



Model 483C28
Sensor Signal Conditioner
Installation and Operating Manual

**For assistance with the operation of this product,
contact PCB Piezotronics, Inc.**

Toll-free: 800-828-8840
24-hour SensorLine: 716-684-0001
Fax: 716-684-0987
E-mail: info@pcb.com
Web: www.pcb.com



The information contained in this document supersedes all similar information that may be found elsewhere in this manual.

Total Customer Satisfaction – PCB Piezotronics guarantees Total Customer Satisfaction. If, at any time, for any reason, you are not completely satisfied with any PCB product, PCB will repair, replace, or exchange it at no charge. You may also choose to have your purchase price refunded in lieu of the repair, replacement, or exchange of the product.

Service – Due to the sophisticated nature of the sensors and associated instrumentation provided by PCB Piezotronics, user servicing or repair is not recommended and, if attempted, may void the factory warranty. Routine maintenance, such as the cleaning of electrical connectors, housings, and mounting surfaces with solutions and techniques that will not harm the physical material of construction, is acceptable. Caution should be observed to insure that liquids are not permitted to migrate into devices that are not hermetically sealed. Such devices should only be wiped with a dampened cloth and never submerged or have liquids poured upon them.

Repair – In the event that equipment becomes damaged or ceases to operate, arrangements should be made to return the equipment to PCB Piezotronics for repair. User servicing or repair is not recommended and, if attempted, may void the factory warranty.

Calibration – Routine calibration of sensors and associated instrumentation is

recommended as this helps build confidence in measurement accuracy and acquired data. Equipment calibration cycles are typically established by the users own quality regimen. When in doubt about a calibration cycle, a good “rule of thumb” is to recalibrate on an annual basis. It is also good practice to recalibrate after exposure to any severe temperature extreme, shock, load, or other environmental influence, or prior to any critical test.

PCB Piezotronics maintains an ISO-9001 certified metrology laboratory and offers calibration services, which are accredited by A2LA to ISO/IEC 17025, with full traceability to N.I.S.T. In addition to the normally supplied calibration, special testing is also available, such as: sensitivity at elevated or cryogenic temperatures, phase response, extended high or low frequency response, extended range, leak testing, hydrostatic pressure testing, and others. For information on standard recalibration services or special testing, contact your local PCB Piezotronics distributor, sales representative, or factory customer service representative.

Returning Equipment – *Following these procedures will insure that your returned materials are handled in the most expedient manner.* Before returning any equipment to PCB Piezotronics, contact your local distributor, sales representative, or factory customer service representative to obtain a Return

Materials Authorization (RMA) Number. This RMA number should be clearly marked on the outside of all package(s) and on the packing list(s) accompanying the shipment. A detailed account of the nature of the problem(s) being experienced with the equipment should also be included inside the package(s) containing any returned materials.

A Purchase Order, included with the returned materials, will expedite the turn-around of serviced equipment. It is recommended to include authorization on the Purchase Order for PCB to proceed with any repairs, as long as they do not exceed 50% of the replacement cost of the returned item(s). PCB will provide a price quotation or replacement recommendation for any item whose repair costs would exceed 50% of replacement cost, or any item that is not economically feasible to repair. For routine calibration services, the Purchase Order should include authorization to proceed and return at current pricing, which can be obtained from a factory customer service representative.

Warranty – All equipment and repair services provided by PCB Piezotronics, Inc. are covered by a limited warranty against defective material and workmanship for a period of one year from date of original purchase. Contact

PCB for a complete statement of our warranty. Expendable items, such as batteries and mounting hardware, are not covered by warranty. Mechanical damage to equipment due to improper use is not covered by warranty. Electronic circuitry failure caused by the introduction of unregulated or improper excitation power or electrostatic discharge is not covered by warranty.

Contact Information – International customers should direct all inquiries to their local distributor or sales office. A complete list of distributors and offices can be found at www.pcb.com. Customers within the United States may contact their local sales representative or a factory customer service representative. A complete list of sales representatives can be found at www.pcb.com. Toll-free telephone numbers for a factory customer service representative, in the division responsible for this product, can be found on the title page at the front of this manual. Our ship to address and general contact numbers are:

PCB Piezotronics, Inc.
3425 Walden Ave.
Depew, NY 14043 USA
Toll-free: (800) 828-8840
24-hour SensorLineSM: (716) 684-0001
Website: www.pcb.com
E-mail: info@pcb.com

SIGNAL CONDITIONER

Model 483C28

GENERAL OPERATION MANUAL

For powering ICP[®], and bridge sensors, this signal conditioner provides an effective method for managing small numbers of sensor channels. A simple command set, entered through industry standard interface, allows the user to generate powerful application-specific programs to automate system testing. A front panel interface is also provided for standalone operation.

43998-NR



PCB PIEZOTRONICS, INC. 3425 WALDEN AVENUE DEPEW, NY 14043-2495 PHONE 716-684-0001 FAX 716-684-0987

[®]ICP is a registered trademark of PCB Group, Inc.

KS398

Table of Contents

Table of Contents	i
1-0 INTRODUCTION AND SPECIFICATIONS	1
1-1 Introduction: Safety Considerations	1
1-2 Model 483C System Description	2
1-2.1 Model 483C ICP [®] Input/Output Mode, All Models	2
1-3 Block Diagram	3
1-4 Installation	3
1-4.1 Grounding Techniques	3
1-4.2 Quick Set-up Instructions	4
1-5 Operation: Standard AC Line	4
3-0 THEORY OF OPERATION	5
3-1 Sensor Excitation	5
3-2 Input Protection	5
3-3 Input Fault Detection	5
3-4 Input Interface	6
3-5 Gain	6
3-5.1 Programmable Gain	6
3-6 Normalized Output Sensitivity	7
3-7 Overload Detection and Autorange	7
3-7.1 Autorange	7
3-7.2 Overload	8
3-8 Filtering	9
3-9 RMS - DC Conversion Every Channel	9
3-10 Connector Configuration	9
3-10.1 ICP [®] , Voltage or Bridge Input per Channel	9
3-11 ICP [®] , Voltage Sensor Connection:	10
3-12 Bridge/Differential Sensor Connection	10
3-13 RS-232 & Ethernet Connections	10
3-14 Non-Volatile Memory	10
3-15 Transducer Electronic Data Sheet (TEDS) Interface	10
4-0 COMPUTER INTERFACE PROGRAMMING GUIDE	11
4-1 Introduction	11
4-2 Ethernet Communication	11

4-3	Model 483C Communication Guidelines	18
4-4	Command Summary	18
4-5	Command Format	19
4-6	Multiple Board Models	19
4-7	Commands	20
	GAIN	20
	SENS	20
	FSCI	21
	FSCO	21
	INPT	21
	IEXC	22
	VEXC	22
	FLTR	23
	OFLT	23
	CLMP	24
	CLPG	24
	SWOT	25
	CALB	25
	RTED	25
	ALLC	26
	RBIA	26
	CHRD	27
	STUS	27
	UNIT	28
	UNID	29
	AZZR	29
	LEDS	30
	RSET	30
	AUTR	30
	SAVS	31
	Communication Responses	31
5-0	Wiring Information	32
5-1	Full Bridge Mode	32
5-2	Half Bridge Mode	33
5-3	Quarter Bridge Mode	34

5-3	RSE / NRSE Mode for 3 Wire Sensors	34
5-4	Connection of Triaxial Sensors	35
Figure 1	Typical Block Diagram of Model 483C28	3
Figure 2	ICP[®] Sensor Excitation	5
Figure 3	Input Fault Window Comparator with LED Indicator	6
Figure 4	Input Amplifier Configuration	6
Figure 5	Selectable Gain Amplifier Configuration	6
Figure 6	Autoscale/Overload Window Comparator	8
Figure 7	Recommended Connections for Full Bridge Type Sensors	32
Figure 8	Alternate Connections for Full Bridge Type Sensors	33
Figure 9	Recommended Connections for Half Bridge Type Sensors	33
Figure 10	Recommended Connections for Quarter Bridge Type Sensors	34
Figure 11	Recommended Connections for 3 Wire Type Sensor	34

1-0 INTRODUCTION AND SPECIFICATIONS

1-1 Introduction: Safety Considerations

WARNING SYMBOLS AND TERMS

The following symbols and terms may be found on the equipment described in this manual.



This symbol on the unit indicates that the user should refer to the operating instructions located in the manual.



This symbol on the unit indicates that high voltage may be present. Use standard safety precautions to avoid personal contact with this voltage.



This symbol indicates that the test fixture, Model 483C, must be connected to earth ground via the power cord.

The **WARNING** heading used in this manual explains dangers that might result in personal injury or death. Always read the associated information very carefully before performing the indicated procedure.

The **Caution** heading used in this manual explains hazards that could damage the instrument.

WARNING 1: *The power supply/signal conditioner should not be opened by anyone other than qualified service personnel.* This product is intended for service by qualified personnel who recognize shock hazards and are familiar with the safety precautions required to avoid injury.

WARNING 2: This equipment is designed with user safety in mind; however, the protection provided by the equipment may be impaired if the equipment is used in a manner not specified by PCB Piezotronics, Inc.

Caution 1: *Cables can kill your equipment.* High voltage Electro Static Discharge (ESD) can damage electrical devices. Similar to a capacitor, a cable can hold a charge caused by triboelectric transfer, such as that which occurs in the following:

- Laying on and moving across a rug.
- Any movement through air.
- The action of rolling out a cable.
- Contact to a non-grounded person

The solution for product safety: 1) Connect the cables only with the AC power off. 2) Temporarily "short" the end of the cable before attaching it to any signal input or output.

Caution 2: *ESD considerations should be made prior to performing any internal adjustments on the equipment.* Any piece of electronic equipment is vulnerable to ESD when opened for adjustments. Internal adjustments should therefore be done **ONLY** at an ESD-safe work area. Many products have ESD protection, but the level of protection may be exceeded by extremely high voltage that is typically present in normal situations.

EQUIPMENT RATINGS

For complete specifications, please refer to the enclosed Specification Sheet. This equipment operates optimally at +32 to +120°F (0 to +50°C), in an environment having <85% relative humidity. Its line power frequency range is 50/60 Hz.

The Model 483C requires 10-15 VDC with 500 mA to operate. In turn, it supplies 24 VDC, 2 to 20 mA excitation voltage to connected ICP® or in-line charge converter sensors. The unit gets its power via AC power adaptor.

1-2 Model 483C System Description

The model 483C28 is an eight-channel, rack mountable signal conditioner that offers low noise operation and simplicity of use. Each channel is selectable between two input types: Bridge/MEMS or ICP®/Voltage.

For the bridge inputs, this model offers up to 12 VDC unipolar or bipolar excitation voltage for use with differential, single-ended, MEMS, and bridge sensors like load cells and reaction torque sensors. This mode features incremental gain of x0.1 to x2000, normalization, shunt calibration and AC/DC coupling. In DC coupled mode, auto-balance and auto-zero functions automatically compensate the internal circuitry to provide a zero based output.

The bridge inputs are compatible with full bridge sensors as well as ½ and ¼ bridge sensors with internal switchable bridge completion resistors. The maximum current available is 30mA, with a current limit set at 40mA to prevent damage from inadvertent shorting.

For the ICP® inputs, the model offers 1 to 20 mA of constant current excitation to power ICP® sensors or in-line ICP® charge converters. This model features incremental gain of x.1 to x200, normalization, and AC/DC coupling. In DC coupled mode, an auto-zero function is available to automatically compensate the internal circuitry to provide a zero based output. In Voltage input mode current excitation is set to 0 mA (off).

The base unit of this model is powered from 9 to 18 VDC but is supplied with a universal voltage, AC power adapter. An optional auto lighter adapter (488A13) is also available.

Model 483C28 offers the following:

- Provides Sensor Excitation Voltage or ICP® Power
- Compatible with Full, ½, and ¼ Bridge Sensors
- Suitable for Conditioning Any Voltage Input Signals
- AC/DC Coupling
- Auto Zero and Auto Balance Functions
- Digital Data Output
- Gain of 0.1 to 2000 for bridge inputs
- Gain of 0.1 to 200 for ICP®/voltage inputs
- Menu-driven Dot Matrix Display
- Keypad, RS-232, and Ethernet Control
- Remote control via Ethernet using the supplied software
- Compatible with PCB's line of DC accelerometers, such as models 3901 and 3741

1-2.1 Model 483C ICP® Input/Output Mode, All Models

The Model 483C contains a regulated 24 VDC power supply that provides constant current for up to 8 individual channels. Both the output and input connections utilize BNC connectors and are brought out through the rear panel.

1-3 Block Diagram

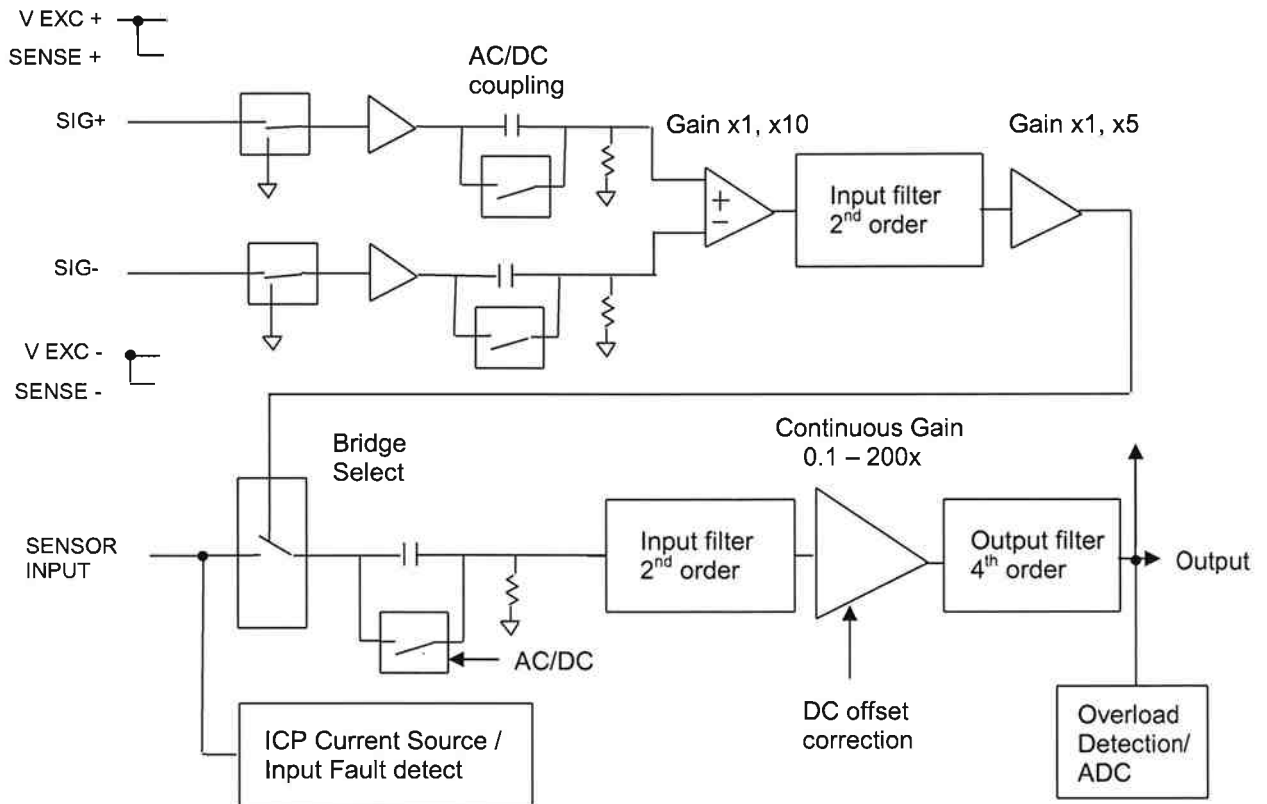

Figure 1 Typical Block Diagram of Model 483C28

1-4 Installation

Model 483C comes in the form of a low profile standard rack mountable unit. It should be located in such a way as to allow convenient access to the power outlet for disconnect purposes. Since these units have low power consumption, they can be located in confined environments.

1-4.1 Grounding Techniques

Integrating the Model 483C unit into an application that links the outputs to other test equipment powered by line voltages may lead to errors or loss of signal-to-noise ratio due to ground loops. The evidence of ground loops is easily seen whenever the fundamental frequency (50 or 60 Hz) or a multiple of the fundamental frequency is present in the system when the sensors are "at rest." In order to maintain the operating

specification of noise and reduce the effects of line interference, proper grounding techniques should be used. The following procedure may be helpful:

1. Make sure the signal ground lines of all equipment are tied together. The signal grounds of the channels are typically tied together via the case of the input and output BNC connectors. The individual channels of the 483C Model have their signal ground lines tied together internally at the power supply.
2. Ensure that the sensor does not pick up line noise from the body under test. The case of the sensor should be isolated from the body (ground) using an isolation pad. The isolation pad breaks the loop formed by the signal path of the sensor to the Model 483C and the return (ground) from the Model 483C back to the sensor.
3. Make sure that all equipment signal grounds of the test system are tied to the Earth ground at a single point and the connections linking the equipment ground are made using a wire that can provide a very low impedance connection.

1-4.2 Quick Set-up Instructions

1-5 Operation: Standard AC Line

Plug the adapter into a 120V/60 Hz or 230V/50 Hz power source and press the "ON/OFF" switch.

1-7 Maintenance and Repair

It is not recommended that the customer attempt repair of the Model 483C28 in the field. Should trouble occur, contact the factory for assistance. If the unit becomes dusty and dirty, it may be wiped off with a soft cloth.

Reference

3-0 THEORY OF OPERATION

3-1 Sensor Excitation

ICP[®] refers to a low output impedance voltage mode sensor combining an integrated circuit and a piezoelectric sensing element in a single housing to provide a voltage output. This sensor is powered by a +24 VDC power supply having a constant current, variable from 2 to 20 mA.

Sensor excitation occurs as the constant current of all channels are set. Model 483C allows the constant current to be adjusted between 2 and 20 mA to provide the required excitation for most applications. Special situations, such as driving extra-long cables (more than 1000 ft) with high frequency or fast rise time pulses, may require increasing the drive current to 12 mA or higher. See Figure 3-1.1.

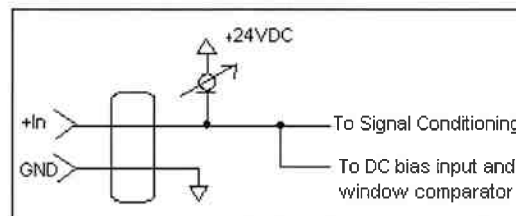

Figure 2 ICP[®] Sensor Excitation

When driving fast rise time pulses over long lines, system performances can be optimized by "tuning" the drive current to the line; i.e. by finding the best current setting for the particular test of physical parameters. To determine the optimal current setting, experiment with your particular test set up. To insure optimal accuracy in constant-current adjustment, make sure all channels have sensors or simulated loads, similar to the one provided by the Model 401A04 Sensor Circuit, consisting of a voltage amplifier similar to those found in ICP[®] sensors.

3-2 Input Protection

The input section has protection to limit the amplitude of the incoming signal to within +24 volts to ground. Maximum allowable input voltage without distortion is ± 10 volts, relative to the sensor bias voltage.

3-3 Input Fault Detection

Model 483C monitors two input fault conditions, "short" and "open," which indicate problems with sensor input and is displayed through the front panel LEDs. Either case implies that the sensor is NOT functioning properly. An input is **shorted** when it has a ground path for the sensor excitation and **open** when the sensor fails to draw the excitation.

Two voltage comparators consist of a window comparator that has two reference voltages (V_{ref}) representing thresholds for “short” and “open.” When the sensor’s bias voltage (V_{bias}) exceeds the comparator range, the front panel input fault LED lights.

NOTE: Red LED implies input fault.

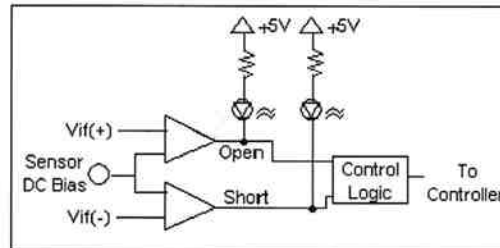

Figure 3 Input Fault Window Comparator with LED Indicator

3-4 Input Interface

The input signal conditioning for each channel provides a unity gain buffer with high-input impedance amplifiers. With the AC coupled option it also eliminates the DC bias from the input signal with a 10-second time constant.

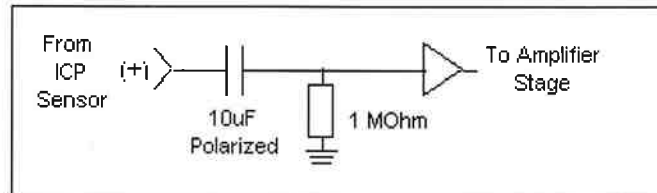

Figure 4 Input Amplifier Configuration

3-5 Gain

The Programmable Gain Amplification (PGA) block consists of a decimal gain amplifier. See Figure 3-5.1.

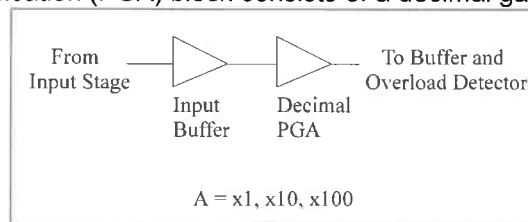

Figure 5 Selectable Gain Amplifier Configuration

3-5.1 Programmable Gain

With the programmable gain setting, the user can adjust the gain as needed (0.1 to 200 in ICP® or Voltage mode and 0.1 to 2000 in differential modes). The step size in the incremental gain option is 0.1. These options are particularly useful in the standardization of groups of sensors. Consider the following example wherein the user desires to normalize sensitivities to 1 V/unit for each channel:

<u>Channel</u>	<u>Sensor Sensitivity</u>	<u>Gain Setting of 483C</u>	<u>Actual Needed</u>	<u>Gain</u>
1 st	10.10 mV/unit	99.00	99.01	
2 nd	101.32 mV/unit	9.9	9.869	
3 rd	22.30 mV/unit	44.8	44.84	

These results may be accomplished by using either of the following two techniques. First, the user may set the gain via the computer interface command set (See the command strings in Section 4-9 in the Computer Interface Programming Guide.) Alternatively, the user may set the gain by using the front panel control.

3-6 Normalized Output Sensitivity

The definition of normalized output sensitivity is the calculation of the individual channel's gain depending on the sensitivity of the sensor attached and the desired output sensitivity. This is simply a function of the desired output sensitivity (in Volts/ unit) divided by the sensor's sensitivity.

$$\text{Gain} = 1 \text{ Volt} / \text{Sensitivity (mV/unit)}$$

Additionally, a feature to improve flexibility allows changing the output level to a value of 5 Volts/ unit instead of normalized 1 Volt/ unit. Some users request the ability calculate the gain using a known input signal along with the sensor sensitivity, and desired output level. The result of the request impacts the formula:

$$\text{Gain} = 1 \text{ Volt} / [\text{Sensitivity (mV/unit)} * \text{Full Scale Input (units)}]$$

Adding some simple error checking to insure the limits of the sensor and gain limits of the signal conditioner are not exceeded completes the normalization process.

$$\text{Gain}_{\text{normalized}} = \text{FSOT (V)} / \text{SENS} * \text{FSIN}$$

Additional Considerations:

The storage of individual channel gains is stored in non-volatile memory locations. The new variables for each channel's sensitivity, Full Scale Output level, and Full Scale Input are stored in non-volatile memory locations when the unit is powered down.

The error checking should provide a flag if the desired normalized output level is not feasible due to gain limitations. The gain required may be too large given the sensor sensitivity defined, or too small which implies the sensor will not be capable of measuring the expected value. The typical sensor will output a signal up to ± 5 Volts. The maximum swing may be used in the error checking.

The 483C has the capability to provide signal conditioning for charge mode sensors in addition to the standard ICP® type. The sensitivity (mV/ pC) of the in-line charge converters (422M) will be stored at final calibration to allow charge mode sensors (pC/ unit) to be normalized.

3.7 Overload Detection and Autorange

3-7.1 Autorange

To avoid overload, the Model 483C28 features autorange for automatic gain adjustment. This function utilizes the channel output A/D to monitor the input signal and adjust the channel's gain until 0.8 of the Full Scale Output setting is observed. The correct procedure for using the autorange feature is as follows:

1. Excite the structure under test.
2. Enable autorange (AUTR on).
3. Wait several seconds, until the unit is stabilized.
4. Disable autorange (AUTR off).
5. Read the gains of all channels.
6. Begin test run.

3-7.2 Overload

The overload feature uses the same window comparator principle previously discussed. The $+V_{ref}$ is equal to the default overload value of ± 10 volts. When the input voltage (V_{signal} of Figure 3-7.1) to the window comparator exceeds the reference voltage limits, overload has occurred and the comparator's output, which is normally "high," becomes "low." This "low" state illuminates the overload LED and triggers the latch of overload detection circuitry. During regular measuring time, the latch holds the occurrence of overloads until the user reads its status through the computer interface.

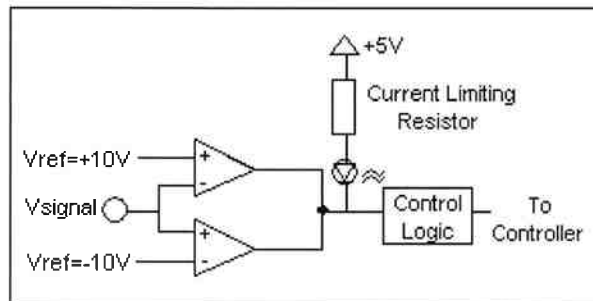

Figure 6 Autoscale/Overload Window Comparator

3-8 Filtering

The Model 483C can be ordered with low pass or high pass filters installed in any or all channels for the removal of unwanted noise. The available filter modules are second and fourth-order Butterworth low pass (-12, -24 dB/octave) filters. High pass filters are available upon request. The filters have a master enable/disable control. In models equipped with a second and fourth order filter, the second order filters may be disabled by individual channel. Typical cutoff frequencies include:

Option Number	Cutoff Frequency (-3 dB)
01	100 Hz
02	200 Hz
03	500 Hz
04	1 kHz
05	2 kHz
06	5 kHz
07	10 kHz
08	20 kHz
09	50 kHz
10	100 kHz

The user may also define a specific cutoff frequency that satisfies a specific need using the Filter Option. Contact the factory regarding individual requirements.

3-9 RMS - DC Conversion Every Channel

This option converts the input AC signal to an equivalent DC signal to provide a cost-efficient, approximate measure of diagnostic information. The effective voltage or current value, when combined with the circuit resistance, determines the average power for a cycle. For example, if the sensed sinusoidal signal is 2 volts peak-to-peak, 1 volt peak, the RMS value may be obtained by multiplying the peak value (1 volt) by 0.707. Maximum output V_{rms} is 5 volts, which corresponds to ± 14.2 volts peak-to-peak, 7 volts peak for a sinusoidal signal.

3-10 Connector Configuration

The base model 483C28 provides BNC inputs for ICP®-type sensors or voltage inputs and an 8 pin DIN connector for Bridge / Differential sensor inputs. The Output connector is a BNC.

3-10.1 ICP®, Voltage or Bridge Input per Channel

This setting allows the user to select the input mode of each channel. The selection is made via RS-232 connection or through the keypad. The functionality of a channel in ICP® or voltage mode is identical except the bias current does not flow in voltage mode. Accordingly, when voltage mode is selected, the unit will automatically set the excitation current to zero (0) mA for the specified channel. With no ICP® excitation present on the input connector, the channel is simply a voltage amplifier.

The factory default is ICP® input mode for all channels in the unit. The user must reconfigure the channels to accept a voltage input signal.

3-11 ICP[®], Voltage Sensor Connection:

The BNC connectors are used to accept ICP[®] and Voltage mode input signals. The ICP[®] excitation will be present on the input BNC only when the ICP[®] current is turned on. The voltage input mode allows bipolar, positive and negative (above and below ground) signals.

3-12 Bridge/Differential Sensor Connection

The following diagram illustrates the proper connections for bridge or differential sensors.

Note: If the Sense lines are not used they should be tied to the excitation lines.

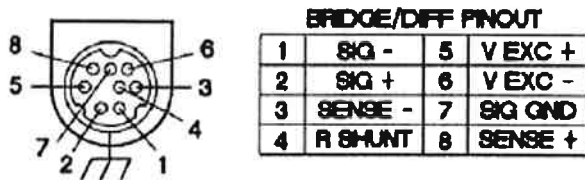

3-13 RS-232 & Ethernet Connections

See section 4 for remote control interface details.

3-14 Non-Volatile Memory

This feature keeps the programmed configurations stored when the unit is powered down. When the unit is turned on, all programmable features (e.g., gains, filter status, switched output settings, overload levels, integration level) active at last use are preserved. When the unit is powered down the non-volatile memory is updated with the current channel settings. The unit's non-volatile memory may be reset to the factory default settings by using the reset menu option.

3-15 Transducer Electronic Data Sheet (TEDS) Interface

The TEDS sensors attach to the input connectors the same way a traditional ICP[®] sensor is attached to the 483C. The TEDS interface requires both the RS-232 or Ethernet computer interface option, and the input mode option. The digital control and input mode features automatically perform the TEDS read or write function. After the communication with the TEDS sensor is complete the input mode returns to the input mode (charge or ICP[®]) prior to the communication.

The current TEDS function will perform a read of the "raw" TEDS data and return the 32 bytes of TEDS sensor EEPROM data and the 8 byte Application Register contents, if it was programmed, and returns the data in an ASCII Hex representation.

4-0 COMPUTER INTERFACE PROGRAMMING GUIDE

4-1 Introduction

The Ethernet Interface enables the Model 483C28 to be remotely controlled. With this interface, the unit is able to become part of a fully automated system.

4-2 Ethernet Communication

The 483C28 unit's IP address must be set up before any remote communication can commence.

The steps to set the IP address of a 483 Unit are as follows:

- Connect, either directly with a crossover CAT5 cable or through a hub, to a single unit. This unit is presumed to have a Unit ID of 1
- Set the IP address using an independent utility from Lantronix called DeviceInstaller™. To download the Lantronix DeviceInstaller™ application go to:
<http://www.lantronix.com/device-networking/utilities-tools/device-installer.html>
- After the DeviceInstaller™ application is installed, run it and the following screen will appear. Click on the Search icon and the program will search for the Ethernet device internal to the 483 unit. When found, as shown below, details about the device show in the list. You can verify it is the correct unit by comparing the Hardware (MAC) Address displayed to the one listed on the side of the 483 unit.

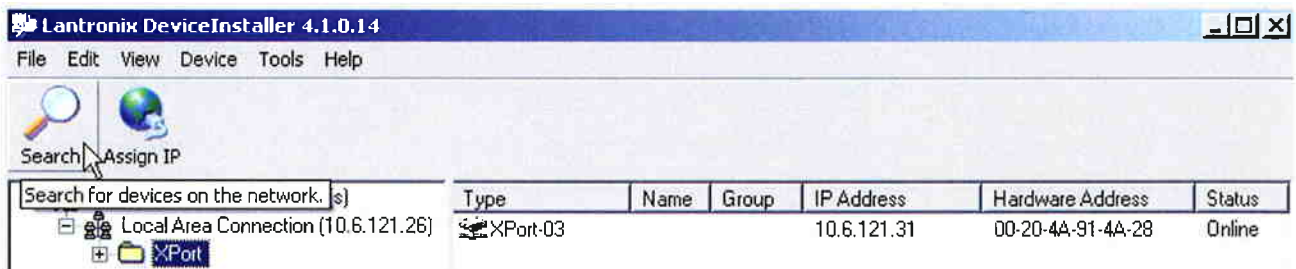

- Selecting an item from the list, shown below, highlights the item in the list and enables more icons.

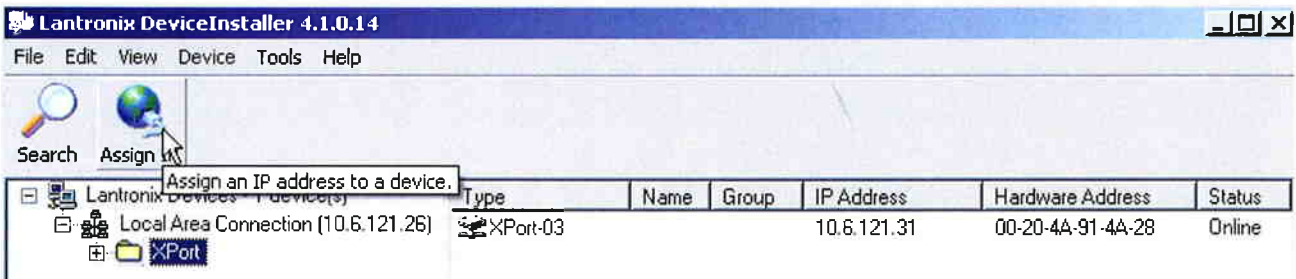

- Select **Assign IP** and the following screen will appear. Select whether you want to assign a static IP address that is appropriate for your network or have it assigned from a network server. Subsequent steps are self-explanatory.

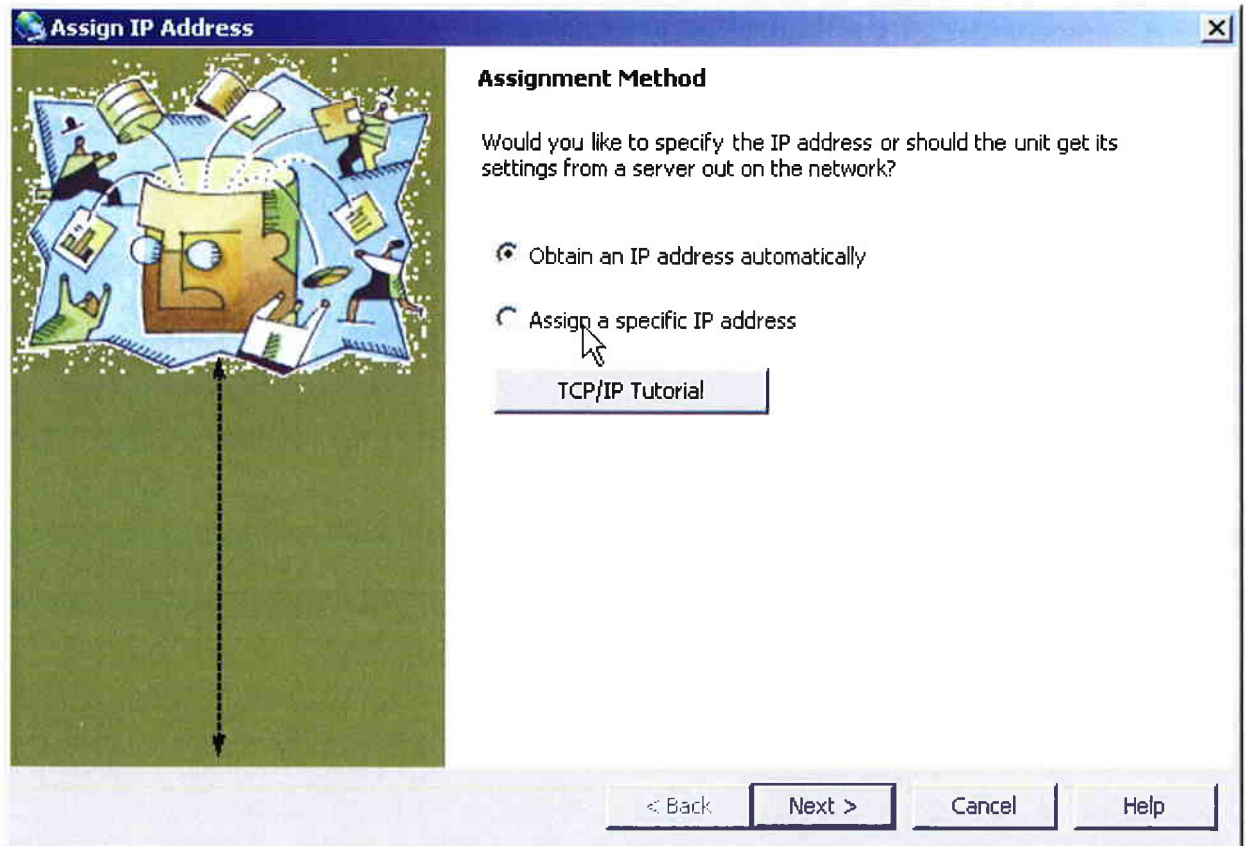

- Now you can use the assigned IP address to address the unit.

Important Note: The communication protocol requires a unit id as part of the command header. The unit id is not the IP address. To send commands to the unit Via Ethernet you must address the TCP-IP packets with the proper IP address and ensure the packet payload contains the correct Unit Id in the command header.

The Lantronix device will be PCB factory set with the proper communication parameters. Some of these parameters though are not the default parameters of this device. In the screens below the fields pointed to with arrows are the modified parameters. Should you need to change them or want to check them if you are experiencing communications problems the following screens will show how it is done.

Note: Port 10001 is the port selected for remote Ethernet communications

To gain access to the Ethernet and serial parameters click on an IP address in the left pane and then on the Web Configuration tab in the right pane as shown below. Then click on the **GO** button.

This will cause the Login Dialog screen to appear (also below). No entries are required since the units are not factory protected, click **OK**.

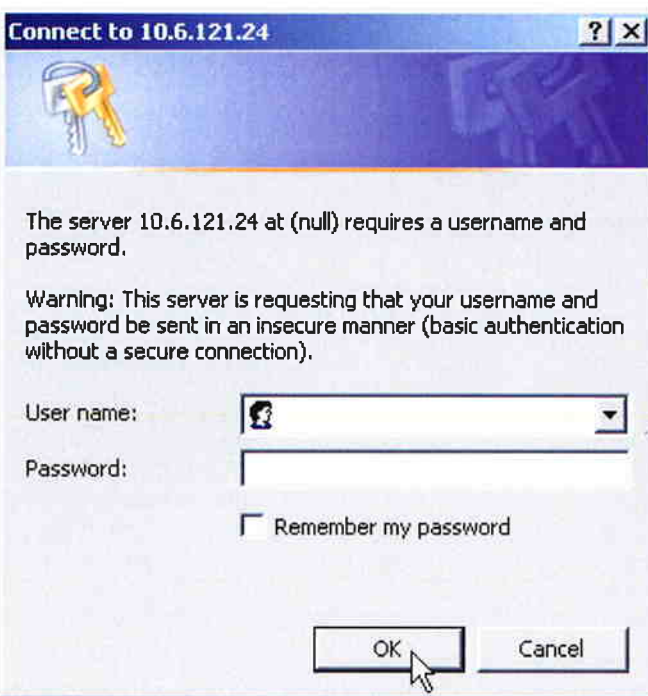
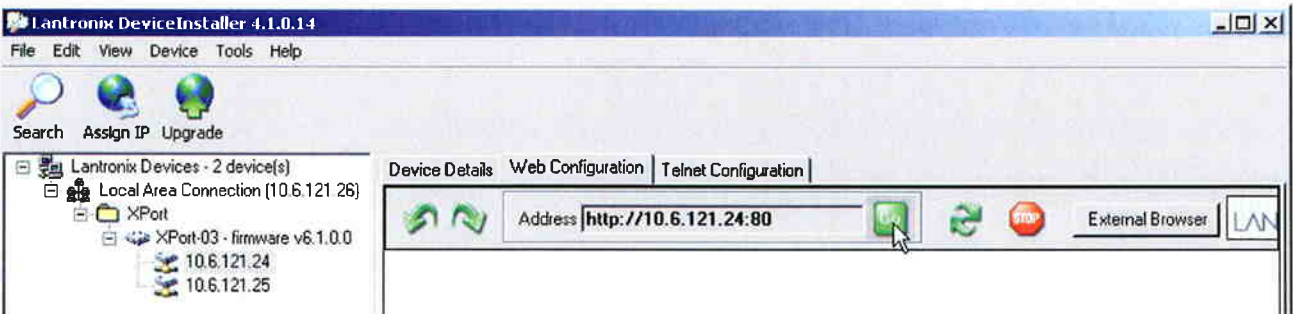

After the Login dialog is completed, the Settings pane will appear on the left as shown below. Click on **Connection**. Make sure the parameters are set as shown. If you need to change the Port # do it here.

Device Details | Web Configuration | Telnet Configuration

Address: External Browser

LANTRONIX® Firmware Version: **V6.1.0.0**
MAC Address: **00-20-4A-91-4A-28**

Connection Settings

Channel 1

Connect Protocol
Protocol:

Connect Mode

Passive Connection:
Accept Incoming:
Password Required: Yes No
Password:

Active Connection:
Active Connect:
Start Character: (In Hex)
Modem Mode:
Mdm Esc Seq Pass Thru: Yes No

Endpoint Configuration:
Local Port: Auto increment for active connect
Remote Port: Remote Host:

Common Options:
Telnet Mode: Connect Response:
Terminal Name: Use Hostlist: Yes No LED:

When finished click **OK** and then activate the **Apply Settings** option.

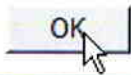

Device Details | **Web Configuration** | Telnet Configuration

Address: External Browser LANTRONIX



Firmware Version: **V6.1.0.0**
MAC Address: **00-20-4A-91-4A-28**

Serial Settings

- [Home](#)
- [Network](#)
- [Server](#)
- [Serial Tunnel](#)
- [Hostlist](#)
- Channel 1**
- Serial Settings
- [Connection](#)
- [Email](#)
- [Serial Settings](#)
- [Trigger 1](#)
- [Trigger 2](#)
- [Trigger 3](#)
- [Configurable Pins](#)
- [Apply Settings](#)
- [Apply Factory Defaults](#)

Channel 1

Disable Serial Port

Port Settings

Protocol: Flow Control:

Baud Rate: Data Bits: Parity: Stop Bits:

Pack Control

Enable Packing

Idle Gap Time:

Match 2 Byte Sequence: Yes No Send Frame Only: Yes No

Match Bytes: Send Trailing Bytes: None One Two
(Hex)

Flush Mode

<p>Flush Input Buffer</p> <p>With Active Connect: <input type="radio"/> Yes <input checked="" type="radio"/> No</p> <p>With Passive Connect: <input type="radio"/> Yes <input checked="" type="radio"/> No</p> <p>At Time of Disconnect: <input type="radio"/> Yes <input checked="" type="radio"/> No</p>	<p>Flush Output Buffer</p> <p>With Active Connect: <input type="radio"/> Yes <input checked="" type="radio"/> No</p> <p>With Passive Connect: <input type="radio"/> Yes <input checked="" type="radio"/> No</p> <p>At Time of Disconnect: <input type="radio"/> Yes <input checked="" type="radio"/> No</p>
---	--

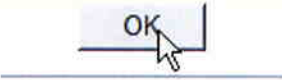
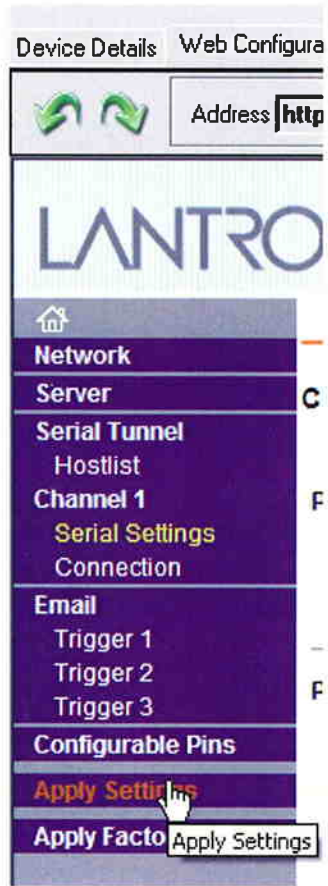

4-3 Model 483C Communication Guidelines

1) Data transfer from the host terminal to the unit must contain an ending delimiter of <CR><LF>.

Example: <CR><LF> -Carriage Return and Line feed. (In ASCII, <CR> is 13; <LF> is 10.)

2) The number of characters for any command string, from the first character to the <CR>, may not exceed 255.

3) Status request commands, i.e., commands ending with a "?", may only be sent within one transmission.

Example: 7:0:GAIN?<CR> <LF> -Reads the gain setting of all channels.

4-4 Command Summary

The table below is a summary of the 483x command set. The 483 is highly configurable and, as such, some commands may not be valid in all units. The 483x commands are sent and received from/to the host computer in ASCII text format.

Command	Type	Scope	Meaning
GAIN	R/W	Channel	Set or read gain
SENS	R/W	Channel	Sensor Sensitivity
FSCI	R/W	Channel	Expected Full Scale Input Value
FSCO	R/W	Channel	Full Scale Output
INPT	R/W	Channel	Input Signal Mode Selection
FLTR	R/W	Channel	Enable/disable input filters
IEXC	R/W	Channel	Read/Adjust ICP® current setting
OFLT	R/W	Channel	Enable/disable output filters
CPLG	R/W	Channel	Select AC or DC coupling
CLMP	R/W	Channel	Enable/disable Clamp
CALB	R/W	Channel	Select Internal/External Cal setting
VEXC	R/W	Channel	Read/Adjust Bridge Voltage Excitation Setting
SWOT	R/W	Unit	Switched output (4 to 1 mux)
RTED	R	Channel	Read TEDS data (DS2430A)
ALLC	R	Channel	Read majority of channel settings
RBIA	R	Unit	Measure Bias (returns all channels)
CHRD	R	Unit	Read Channel output (returns all channels)
STUS	R	Unit	input fault / overload status, for all channels
UNIT	R	Unit	Read Unit Configuration information
UNID	R/W	Unit	Set Unit ID
AZZR	FCN	Channel	AutoZero/Auto Balance
LEDS	FCN	Unit	Front panel LED test function
RSET	FCN	Unit	Restores factory default channel settings
AUTR	FCN	Channel	Enable/disable auto-scaling function
SAVS	FCN	Unit	Saves the current settings to NVRAM

Command type definitions;

- R/W – the setting can be read from or written to the unit or channel.
- R – The information can only be read from the unit or channel.
- FCN – The command invokes a function in the unit.

4-5 Command Format

The 483x communication protocol incorporates the concept of 'Directed' and 'Global' commands at both the Unit and Channel level with the following characteristics:

- Unit or Channel numbers =0 are global commands that affect either all units or all channels of a particular unit or both.
- Directed commands that set a unit parameter are always acknowledged (ACK) with an ASCII message that indicates '<Unit#>:<CMD>:ok' if implemented with no errors or NAK with; '<Unit#>:<CMD>:=<error#>' if an error was encountered.
- Directed commands that request a particular parameters setting (query) result in a query response being returned.
- No response is ever given to a Global Unit command.
- All messages must be terminated with a <CR> (\r) and <LF> (\n) combination.

Command Format:

'Unit#:Ch#:Cmd[=?]{<value1 >{,< value2 >}};Ch#:Cmd[=?]{<value1>{,< value2>}}\n\r

- Each message must be preceded by a Unit# & Channel# (both of which could be 0).
- Messages may contain multiple commands separated by a semicolon ';'.
- The second and subsequent commands in a message shall not contain a unit number but shall contain a channel number.
- Each command in a message will evoke a response message if one is warranted (not global).
- Query's ('?') can only be directed to one unit but if the channel=0 then each channel's setting will be returned in the order 0-MAXCHANNELS separated by a ':'.

Command examples:

1:0:GAIN=100.2\r\n	unit 1, all channels gain set to 100.2
1:1:GAIN=100.2;2:GAIN=120.3\r\n	unit 1, channel 1 gain = 100.2; channel 2 gain = 120.3
1:3:GAIN=100.2;0:FLTR=1\r\n	unit 1, channel 3 gain = 100.2; all channel's filter = ON

General Query Response Format

Unit#:Cmd:Ch#=<value>; Ch#=<value>...>; Ch#=<value>...\r\n

Responses to a query with a channel number=0 will return the setting of each channel in a list separated by semicolons ';'.

If the target of the query is a unit setting (ex. current excitation) then the channel number returned is the 1st channel of the board that processed the command.

4-6 Multiple Board Models

The 483x models have multiple main boards installed which will appear as a contiguous set of channels, when in fact, physically, they are completely separate and operate somewhat independently. This requires special consideration when communicating remotely. For instance, a global channel command to set 8 channels on a 483C28 unit will be handled by each internal board simultaneously. However only the board with the channels designated as 1-4 will ACK the command, the other board will remain silent.

Likewise, a global Query command will be responded to by the channel 1-4 board but will be ignored by the channel 5-8 board. However, In order to facilitate efficient communications with the second board, the concept of a second unit address was introduced. A user's control application can direct global channel setting queries to the second board of a unit by addressing the query to the secondary unit address of the unit. This secondary unit address is defined to be the normal unit address **plus 128** (i.e. if a unit's address is 1 then the 2nd board's address would be 129)

4-7 Commands

GAIN

SET GAIN: This command sets the programmable gain of a channel. The gain may be set to a value of 0.1 to 200 for ICP® or Voltage Modes and 0.1 to 2000 for differential input modes.

Setting:

The amplifier gain can be set directly by sending a Gain command:

1:0:GAIN=100.2\r\n (unit 1,all channels gain set to 100.2)

When a channel's gain is set directly the unit will adjust the FSI parameter of the gain equation using the following equation; $FSI = (((FSO*1000)/Gain)/Sens)$ to ensure it remains valid.

Setting Response: 1:GAIN:ok

Query:

The Gain query returns all of the parameters used to determine it in a single response.

Query Format: Unit#:Ch#:CMD?

Response format: Unit#:Cmd:Ch#:=Gain:SENS:FSO:FSI;

Query: 1:5:GAIN?

Response: 1:GAIN:5= 5.0: 10.0: 10.0: 200.0;

Global Query: 1:0:GAIN?

Global Response: 1:GAIN:1= 5.0: 10.0: 10.0: 200.0;2= 5.0: 10.0: 10.0: 200.0;3= 5.0: 10.0: 10.0: 200.0;4= 5.0: 10.0: 10.0: 200.0;

SENS

The SENS command provides a mechanism to have the transducer Sensitivity influence the Gain setting of the channel. Channel Gain is calculated using the equation:

$$\text{Gain} = \text{FSO} * 1000 / (\text{FSI} * \text{SENS})$$

If a Sensitivity is entered that caused the gain to exceed the amplifiers capability the FSI component will be adjusted to keep the equation valid.

Setting:

1:0:SENS=20.2\r\n (unit 1,all channels transducer sensitivity set to 20.2)

Setting Response: 1:SENS:ok

Query:

The Sens query returns the channels transducer sensitivity.

Query Format: Unit#:Ch#:CMD?

Response format: Unit#:Cmd:Ch#:= SENS;

Query: 1:1:SENS?

Response: 1:SENS:1= 6.0;

Global Query: 1:0:SENS?

Global Response: 1:SENS:1= 6.0;2= 10.0;3= 10.0;4= 10.0;

FSCI

The FSCI command provides a scaling mechanism to automatically set the gain based on a known input level (in EU) and what output level (in Volts) you would like the Full Scale input level to be represented by. For instance, 1000g's = 10Volts. These 2 values, along with the transducer sensitivity, set the gain. Channel Gain is calculated using the equation: $\text{Gain} = \text{FSO} * 1000 / (\text{FSI} * \text{SENS})$.

Setting:

1:1:FSCI=1000.000\r\n (unit 1, channel 1 FSI set to 1000.0)

Setting Response: 1:FSCI:ok

Query:

The FSCI query returns the channels Full Scale Input value in engineering units.

Query Format: Unit#:Ch#:CMD?

Response format: Unit#:Cmd:Ch#:= <fsci>;

Query: 1:1: FSCI?

Response: 1:FSCI:1=1000.0;

Global Query: 1:0:FSCI?

Global Response: 1:FSCI:1=1000.0;2=1000.0;3=1000.0;4=1000.0;

FSCO

The FSCO command provides a scaling mechanism to automatically set the gain based on a known input level (in EU) and what output level (in Volts) you would like the Full Scale input level to be represented by. For instance 1000g's = 10Volts. These 2 values, along with the transducer sensitivity, set the gain. Channel Gain is calculated using the equation:

$\text{Gain} = \text{FSO} * 1000 / (\text{FSI} * \text{SENS})$.

Setting:

1:1:FSCO=10.000\r\n (unit 1, channel 1 FSO set to 10.0)

Setting Response: 1:FSCO:ok

Query:

The FSCO query returns the channels Full Scale Output Value in volts.

Query Format: Unit#:Ch#:CMD?

Response format: Unit#:Cmd:Ch#:= <fsci>;

Query: 1:1: FSCO?

Response: 1:FSCO:1=10.0;

Global Query: 1:0:FSCO?

Global Response: 1:FSCO:1=10.0;2=10.0;3=10.0;4=10.0;

INPT

The INPT command sets the input mode for a given channel. The mode selection is sent as an integer value. All possible input modes for the 482/483 family are listed below. The **bold** items are valid input settings for the 483C28 and 482C27 units.

- CHARGE 0
- **VOLTAGE** 1
- **ICP[⊙]** 2
- Multi-Charge option of 10mV/pc sensitivity 3
- Multi-Charge option of 1.0mV/pc sensitivity 4
- Multi-Charge option of 0.1mV/pc sensitivity 5
- Isolated ICP[⊙] 6

- Isolated Multi-Charge option of 10mV/pc sensitivity 7
- Isolated Multi-Charge option of 1.0mV/pc sensitivity 8
- Isolated Multi-Charge option of 0.1mV/pc sensitivity 9
- **¼ Bridge** 10
- **½ Bridge** 11
- **Full Bridge** 12
- **Referenced Single Ended** 13

Setting:

1:1:INPT= 12 (unit 1, channel 1 input mode set to Full Bridge)

Setting Response: 1:INPT:ok

Query:

The INPT query returns the channels input mode selection.

Query Format: Unit#:Ch#:CMD?

Response format: Unit#:Cmd:Ch#:= <inpt>;

Query: 1:1:INPT?

Response: 1:INPT:1= 12;

Global Query: 1:0:INPT?

Global Response: 1:INPT:1= 12.0;2= 2.0;3= 2.0;4= 2.0;

Note: Programmatic setting of Input mode should be followed with queries of IEXC, VEXC, and GAIN since the unit will set IEXC to 0 if a Bridge input is selected and likewise will set VEXC to 0 if ICP[©] or Voltage input is selected. Additionally, Bridge gain can be as high as 2000, but the ICP[©]/Voltage mode maximum is 200 so switching from Bridge to ICP[©]/Voltage will reset the Gain to the ICP[©] maximum if the current Bridge setting is higher than the ICP maximum.

IEXC

The IEXC command sets the current excitation level for ICP[©] mode. The current excitation value is sent as an integer value from 0 (off) to 20mA.

Setting:

1:1:IEXC= 2 (unit 1, channel 1, set to 2mA)

Setting Response: 1:IEXC:ok

Query:

The IEXC query returns the units excitation value.

Query Format: Unit#:Ch#:CMD?

Response format: Unit#:Cmd:Ch#:= <IEXC>;

Query: 1:1:IEXC?

Response: 1:IEXC:1=2;

Global Query: 1:0: IEXC?

Global Response: 1:IEXC:1=2;2=4;3=4;4=4;

VEXC

The VEXC command sets the voltage excitation level for bridge and differential mode inputs.

The voltage excitation value is sent as a floating point number from 0.0 (off) to ± 12.0 Volts. If the value is sent as a negative number then the minus (-) Bridge Excitation will track the plus (+) Bridge Excitation setting. If it is sent as a Positive value then the minus (-) Bridge Excitation will be set to 0.

Setting:

1:1:VEXC= -10.0 \r\n (unit 1, channel 1, sets minus (-) Bridge Excitation and plus (+)Bridge Excitation to 10.0 volts)

1:1:VEXC= 10.0 \r\n (unit 1, channel 1, sets minus (-) Bridge Excitation to 0 and plus (+)Bridge Excitation to 10.0 volts)

Setting Response: 1:VEXC:ok

Query:

The VEXC query returns the voltage excitation value.

Query Format: Unit#:Ch#:CMD?

Response format: Unit#:Cmd:Ch#:= <VEXC>;

Query: 1:1:VEXC?

Response: 1:VEXC:1=-10.0;

Global Query: 1:0: VEXC?

Global Response: 1:VEXC:1=-10.0;2=10.0;3=0.0;4=0.0;

FLTR

The FLTR command enables or disables the Input Filter.

The Input Filter value is sent as an integer value of either 0 -Disable or 1-Enable.

Setting:

2:1:FLTR= 1\r\n (unit 2, channel 1, Input Filter Enabled)

Setting Response: 2: FLTR:ok

Query:

The FLTR query returns the channels Input Filter selection

Query Format: Unit#:Ch#:CMD?

Response format: Unit#:Cmd:Ch#:= <0|1>;

Query: 2:1: FLTR?

Response: 2:FLTR:1=1;

Global Query: 1:0: FLTR?

Global Response: 1:FLTR:1=1;2=0;3=0;4=0;

OFLT

The OFLT command enables or disables the Output Filter.

The Output Filter value is sent as an integer value of either 0 -Disable or 1-Enable.

Setting:

2:1:OFLT= 1\r\n (unit 2, channel 1, Output Filter Enabled)

Setting Response: 2: OFLT:ok

Query:

The FLTR query returns the channels Output Filter.

Query Format: Unit#:Ch#:CMD?
Response format: Unit#:Cmd:Ch#:= <0|1>;
Query: 2:1: OFLT?
Response: 2: OFLT:1=1;

Global Query: 1:0: OFLT?
Global Response: 1: OFLT:1=1;2=0;3=0;4=0;

CLMP

The CLMP command enables or disables the Clamp feature. When Clamp is disabled the channel is 'Buffered'. The Clamp value is sent as an integer value of either 0 –Disable (buffered) or 1-Enable.

Setting:
2:1:CLMP= 1\r\n (unit 2, channel 1, Clamp Enabled)
Setting Response: 2: CLMP:ok

Query:
 The CLMP query returns the channels Clamp setting.
Query Format: Unit#:Ch#:CMD?
Response format: Unit#:Cmd:Ch#:= <0|1>;
Query: 1:1:CLMP?
Response: 1:CLMP:1=0;

Global Query: 1:0:CLMP?
Global Response: 1:CLMP:1=0;2=0;3=0;4=0;

CLPG

The CLPG command sets the channel coupling to AC or DC mode. The coupling value is sent as an integer value: 0 –AC, 1-DC.

Setting:
1:1:CLPG= 1\r\n (unit 1, channel 1, DC Coupled)
Setting Response: 2: CLPG:ok

Query:
 The CLPG query returns all channels coupling setting.
Query Format: Unit#:Ch#:CMD?
Response format: Unit#:Cmd:Ch#:= <0|1>;
Query: 1:1:CLPG?
Response: 1:CPLG:1=1;2=0;3=0;4=0;

Global Query: 1:0:CPLG?
Global Response: 1:CPLG:1=1;2=0;3=0;4=0;

Notes on DC Coupling

If the Coupling setting is set to DC then the Auto Zero function becomes available. Additionally, if the Input mode is set to any Bridge or differential setting then Auto Balance is also available. These functions remove the DC offset from the output.

SWOT

The Switched Output (SWOT) command selects which channel is switched to the switched output BNC for monitoring purposes as well as its normal analog output. This is a unit command so the channel designation in the command protocol is ignored

The switched output value is sent as an integer value: 0-OFF; or 1-MAX Channels to designate which channel is switched.

Setting:

1:0:SWOT= 4\r\n (unit 1, channel NA, Channel 4 is switched to the switched output BNC)

Setting Response: 1: SWOT:ok

Query:

The SWOT query returns all channels coupling setting.

Query Format: Unit#:Ch#:CMD?

Response format: Unit#:Cmd:Ch#:= <channel # or 0=OFF>;

Query: 1:1:SWOT?

Response: 1:SWOT:1=4;

CALB

The Calibration mode (CALB) command selects the calibration setting. For the 483C28 the options are OFF, Internal Shunt +, or Internal Shunt -. For other models, External Cal and Internal Cal using internally generated 100Hz or 1kHz sine wave signals are available.

The CALB value is sent as an integer value of either 0 –Disable, 1-1000 Hz Enable, 2-100 Hz Enable, 3- External Cal, 4 -Internal Shunt +, or 5 – Internal Shunt -.

Setting:

1:1: CALB= 4\r\n (unit 1, channel 1, Internal Shunt Cal +)

Setting Response: 1:CALB:ok

Query:

The CALB query returns the channels calibration setting.

Query Format: Unit#:Ch#:CMD?

Response format: Unit#:Cmd:Ch#:= <0|1>;

Query: 1:1: CALB?

Response: 1: CALB:1=4;

Global Query: 1:0:CALB?

Global Response: 1:CALB:1=4;2=0;3=0;4=0;

RTED

The Read TEDS (RTED) command returns the TEDS information that is stored in the sensor or other, TEDS capable, in-line module attached to a selected channel. The 483x devices are 1451.4 compliant in that they will read the DS2430A Application Register Status to see if it indicates the 64 bit Application Register has data in it. If so it will read the Application Register contents and return it followed by the contents of the TEDS EEPROM.

NOTE: The 1st byte of the DS2430A EEPROM data should contain the checksum of both the Application Register contents and the EEPROM contents if the TEDS is 1451.4 compliant. No attempt is made to validate or interpret the TEDS data.

Setting:**N/A – Command is Read only****Query:**

The RTED query returns the TEDS data associated with the specified channel. This command must be directed to a specific channel. It will return an indicator that specifies if the DS2430A Application Register has been used to store the basic TEDS data and up to 40 bytes in ASCII Hex format (8 bytes of Application register content if it was burned and 32 bytes of the EEPROM content).

Query Format: Unit#:Ch#:CMD?**Response format:** Unit#:Cmd:Ch#= <APP Reg Status>:<APP Reg Contents (8 bytes if APP Reg Status=1)><DS2430A EEPROM Contents (32 bytes)>

Where: APP Reg Status=1 if the APP Register had data or 0 if it did not

Query: 1:1:RTED?**Response:** (for TEDS chip (DS3430A) on channel 1 with valid app register data)

1:RTED:1=1:168010a00975000012648016a88ae8e112801f2000f60ec4046dd18737f3206a380555e765390800

Note: the following error code could be reported by the Read Teds function:

- -19 TEDS read request when Channel is not in ICP or Voltage Mode error

ALLC

The ALLC command is used to read several channel settings at once.

Setting:**N/A – Command is Read only****Query:**

This command must be a directed command use of the global channel indicator is not allowed.

Query Format: Unit#:Ch#:CMD?**Response format:** Unit#:Cmd:Ch#= GAIN:<Gain value>; SENS:< SENS value>; FSCI:< FSCI value>; FSCO:< FSCO value>; INPT:< INPT value>; FLTR:< FLTR value>; IEXC:< IEXC value>; OFLT:< OFLT value>; CPLG <CLPG value>; CLMP:< CLMP value>; CALB:< CALB value>; VEXC:< VEXC value>; SWOT:< SWOT value>;**Query:** 1:1:ALLC??**Response:** 1:ALLC:1=GAIN: 2.7;SENS: 10.0;FSCI: 187.7;FSCO: 5.0;INPT: 2.0;FLTR:0;IEXC :2;OFLT:0;CPLG:1;CLMP:0;CALB:0;VEXC: 0.0;SWOT:0;**RBIA**

The RBIA command is used to read all channels Bias Levels.

Setting:**N/A – Command is Read only****Query:**

This command is a global command and will return all channel bias readings regardless of the channel id in the command.

Query Format: Unit#:Ch#:RBIA?

Response format: Unit#:Cmd:Ch#:=CH1 bias;... CHn#:=CHn bias;

Query: 1:1:RBIA?

Query Response: 1:RBIA:1= 12.5;2= 25.5;3= 25.5;4= 25.5;

CHRD

The CHRD command is used to read all channels output levels.

Setting:

N/A – Command is Read only

Query:

This command is a global command and will return all channel A/D readings regardless of the channel id in the command.

Query Format: Unit#:Ch#:CHRD?

Response format: Unit#:Cmd:Ch#:=CH1 A/D;... CHn#:=CHn A/D;

Query: 1:0:CHRD?

Query Response 1:CHRD:1= 4.049;2=5.338;3=2.137;4=10.373;

STUS

The STUS command is used to read the unit and all channel status indicators.

Setting:

N/A – Command is Read only

Query:

This command is a global command and will return all channel bias readings regardless of the channel id in the command.

Query Format: Unit#:Ch#:STUS?

Response format: Unit#:Cmd:Ch#:<unit status bit map>;<CH1 status bit map>;...;<CHn status bit map>;

Query: 1:1:STUS?

Query Response: 1:STUS:1:0;1;5;5;5;

Where :

Unit Bit 0 = 1= BAD EEPROM read for channel settings on power up

Unit Bit 1 = 1= BAD EEPROM read for Unit options on power up

Unit Bit 2 = 1= BAD EEPROM read for cal factors on power up

For Unit bit map 0=no errors

Channel Bit 0= Short input fault (0=Fault; 1 = no fault)

Channel Bit 1= Open input fault (0=Fault; 1 = no fault)

Channel Bit 2= Overload condition (0=Overload; 1 = no Overload)

For channel bit map 7=no errors

UNIT**Query:**

The UNIT query returns the unit configuration information which includes the installed options, unit number, Model id, and starting channel number.

Query Format: Unit#:Ch#:CMD?

Response format: Unit#:Cmd:Model string:Firmware Ver string: Serial Number:Cal Date:Filter Corner: Unit#:#channels:Starting Ch#: Gain Option byte, Input Option Byte, Filter option byte,Misc1 option byte,Misc2 option byte<cr><lf>

Query: 1:1:UNIT?

Response: 1:UNIT:483C28\s\s\s\s\s\s\s\s:FW\sVer\s1.0:12345:09-27-2006:10.000:1:4:1:16,37,1,143,0\r\n

Model & Firmware version strings are self-explanatory. Following them is the Serial Number (U16): Cal Date (10 character string): Filter corner (kHz): Unit Id: Number of Channels: Starting Channel # Followed by the 5 option bytes:

Gain Options

OPT_GAIN_x1	0x01	Fixed x1
OPT_GAIN_x5	0x02	Fixed x5
OPT_GAIN_x10	0x04	Fixed x10
OPT_GAIN_VAR	0x08	Variable Fixed (x1,x10,x100)
OPT_GAIN_INC	0x10	incremental .1-200
OPT_GAIN_FINE2h	0x20	Fine Gain .0025-200
OPT_GAIN_FINE1k	0x40	Fine Gain .0025-1000

Input Options

OPT_INP_ALLCHG	0x01	All charge
OPT_INP_ICPVOLTCHG	0x02	ICP VOLT CHG
OPT_INP_ICPVOLT	0x04	ICP VOLT
OPT_INP_INTCAL	0x08	Internal Cal
OPT_INP_EXTCAL	0x10	External Cal
OPT_INP_ISOLATION	0x20	Isolation
OPT_INP_BRIDGE	0x40	Bridge Modules Installed

Filter Options

OPT_FILTER_IN	0x01	Input filter (time constant)
OPT_FILTER_OUT	0x02	Output filter
OPT_FILTER_FIXLP	0x04	Fixed LP filter
OPT_FILTER_PGMELP	0x08	Prgm LP Elliptical filter
OPT_FILTER_PGMBTR	0x10	Prgm LP Butterworth filter

Miscellaneous Options

OPT_MISC_COUPLING	0x01	AC/DC coupling
OPT_MISC_CLAMP	0x02	Clamp
OPT_MISC_TEDS	0x04	TEDS
OPT_MISC_IEXC	0x08	current excitation
OPT_MISC_SINTG	0x10	Single Integration
OPT_MISC_DINTG	0x20	Double Integration
OPT_MISC_MUX	0x40	Mux /Switch-out
OPT_MISC_DISPLAY	0x80	FP Display

Miscellaneous Options 2

OPT_MISC2_OLDISO	0x01	Reserved
OPT_MISC2_A2D	0x02	Digital Output available

UNID

The UNID command is used to set the units ID number. The Unit Id number is critical to remote communications since it indicates which commands a unit should accept and respond to. Units are typically shipped with a unit id of 1. If more than one unit is in the system and they will be communicated with remotely the user must set a unique id in each unit. This can be done through the front panel interface, if one exists, or by connecting to each unit individually and sending this command.

Setting:

1:1:UNID= 2\r\n(unit 1, channel 1, New ID=2)

Setting Response: 2:UNID:ok

NOTE: The new Unit Id becomes effective immediately.

Query:

This command can be sent as a query, but its usefulness is marginal since it is a directed command. As such, it is necessary to include the Unit Id in the command and the response will simply validate the commands unit id parameter.

Query Format: Unit#:Ch#:UNID?

Response format: Unit#:Cmd:Ch#:=unit id

Query: 2:1:UNID?

Query Response: 2:UNID:1=2;

AZZR

The AZZR command is used to Auto Zero (input shorted) or Auto Balance (input connected) a channel that is DC coupled. This command invokes a function and therefore has no query capability. The function parameters are: 1=Auto Zero, 2=Auto Balance. (Auto Balance is only valid if the channel has a bridge input type selected).

Setting:

2:1:AZZR= 1\r\n (unit 2, channel 1, Auto Zero)

Setting Response: 2:AZZR:ok

Query:

N/A

Note: the following error codes could be reported by the auto zero/balance function:

- -11 Bridge DC Offset ERR - Illegal Setting
- -12 Bridge DC Offset ERR - Too Many iterations
- -13 ICP DC Offset ERR - Bad RDG
- -14 ICP DC Offset ERR - Too Many iterations
- -15 Balance Request, channel not in Bridge mode - Illegal Setting
- -16 Zero Request, channel not in Bridge mode or ICP/volt - Illegal Setting
- -17 Current Excitation Setting not allowed in Bridge input modes – Illegal Setting
- -18 Voltage Excitation Setting not allowed in non-Bridge input modes – Illegal Setting

LEDS

The LEDS command is used to test the LED functionality of the front panel. When sent as a command the LED's on the front panel will flash 3 times. This command invokes a function and therefore has no query capability.

Setting:

2:1:LEDS= 0\r\n (unit 2, channel 1, Any value)

Setting Response: 2:LEDS:ok

Query:

N/A

RSET

The RSET command is used to restore the factory default channel settings for every channel in the specified unit. This command invokes a function and therefore has no query capability.

Setting:

2:0:RSET = 1\r\n (unit 2, channel 0, RSET cmd, 1(TRUE))

Setting Response: 2:RSET:ok

Query:

N/A

The factory Defaults are:

- Gain= 1.0
- Sensitivity=10.0
- Full Scale input= 1000.0
- Full Scale output= 10.0
- Input Mode = ICP
- Input Filter=Disabled
- Current excitation=4.0mA
- Voltage Excitation=0 volts
- Output Filter=Disabled
- Coupling =AC
- Clamp=OFF
- Calibration=OFF
- Switched Output =OFF

AUTR

The AUTR command invokes the Auto-Range function. This function (also referred to as auto-scale) provides an automatic scaling of the output signal by adjusting the programmable gain to give 0.8 of the Full Scale Output setting. The signals are checked internally using the onboard channel output A/D. Possible settings are: **0=off, 1=on, 2=immediate**. The Immediate option causes the auto scale function to execute one time and then turns off the function automatically. When Auto scale is 'ON' the unit will continue to invoke the function, adjusting the gain for the current input level, until the function is turned OFF with a subsequent command.

Setting:

2:1:AUTR =1\r\n (unit 2, channel 1, Auto Scaling ON)

Setting Response: 2:AUTR:ok

Query:

Query Format: Unit#:Ch#: AUTR?

Response format: Unit#:Cmd:Ch#:=current state (0=off,1-on,2=immediate)

Query: 2:1:AUTR?

Query Response: 2:AUTR:1=0;

SAVS

The SAVS command is used to store the current channel setting as the default settings that will be restored on power up. This command is available primarily for units without a front panel display and keypad. Units with a soft key power button will save the channel settings automatically at power down because the units firmware handles the power button processing. Units without the soft key have power removed abruptly and do not have the opportunity to save the settings automatically. This command invokes a function and therefore has no query capability.

Setting:

2:1:SAVS = 1\r\n (unit 2, channel 1, Any value)

Setting Response: 2:SAVS:ok

Query:

N/A

Communication Responses

Typically the unit will return **<Unit>:<Cmd String>:OK** when the command is successful. Errors are indicated with negative numbers. The unit may return one of the following:

<Unit>:<Cmd String>:OK<CR> <LF>

Represents that the last command was entered in the correct format and was performed properly.

<Unit>:<Cmd String>:-1<CR> <LF>

Option Error. The unit is not equipped with the option necessary to implement the command sent

<Unit>:<Cmd String>:-2<CR> <LF>

Channel Error. The channel number in the command is invalid.

<Unit>:<Cmd String>:-3<CR> <LF>

Command Error. The command is not recognized.

<Unit>:<Cmd String>:-4<CR> <LF>

Unit Error. The unit number in the command is invalid.

<Unit>:<Cmd String>:-5<CR> <LF>

Unit Error. The function invoked by the command encountered an error or a query only command (ex. RBIA) was sent as a setting.

<Unit>:<Cmd String>:-6<CR> <LF>

Command Parameter Error. A channel setting parameter was found to be out of range.

5-0 Wiring Information

Each BRIDGE/DIFF input may be configured for use with full bridge, half bridge, or quarter bridge sensors. Full bridge mode can also be used to accept a differential voltage signal from any source. Two additional modes, RSE (Referenced Single Ended), and NRSE (NOT Referenced Single Ended) accommodate voltage inputs, such as 3 wire sensors with a voltage output. In all cases the SENSE and EXC lines must be connected. The figures below illustrate the connections in each of these modes. Note: the shell of the DIN connector is connected as shown to earth ground internally.

5-1 Full Bridge Mode

Figure 7 and Figure 8 show how the unit should be wired to a full bridge sensor. For optimum performance, the V EXC and SENSE lines should be connected at the sensor as shown in Figure 7 below.

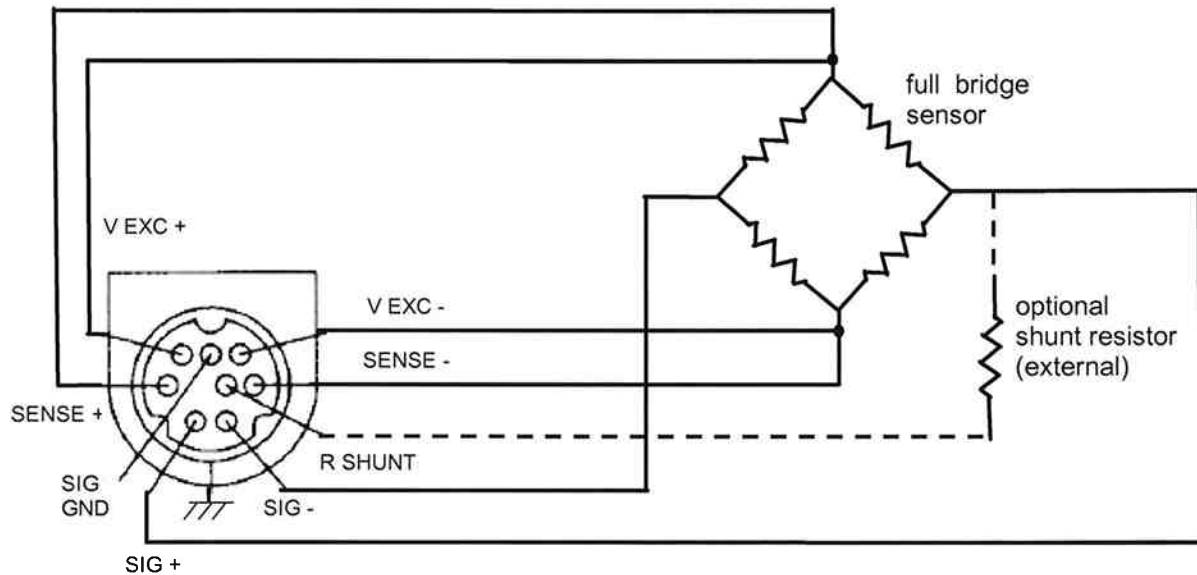

**Figure 7 Recommended Connections for Full Bridge Type Sensors
(sense leads wired for optimum performance)**

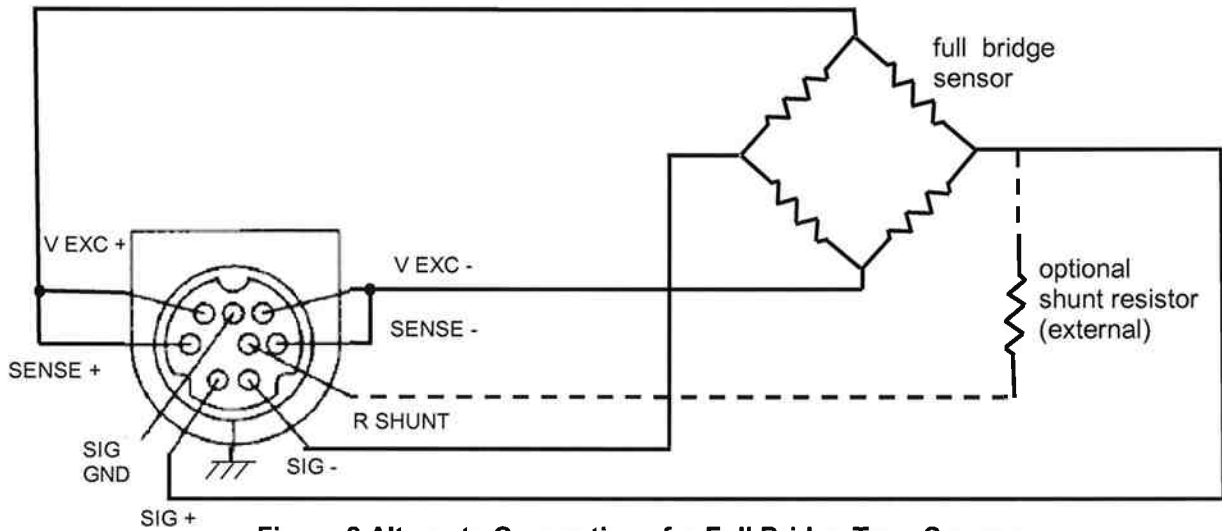

Figure 8 Alternate Connections for Full Bridge Type Sensors
(sense leads connected at the signal conditioner)

5-2 Half Bridge Mode

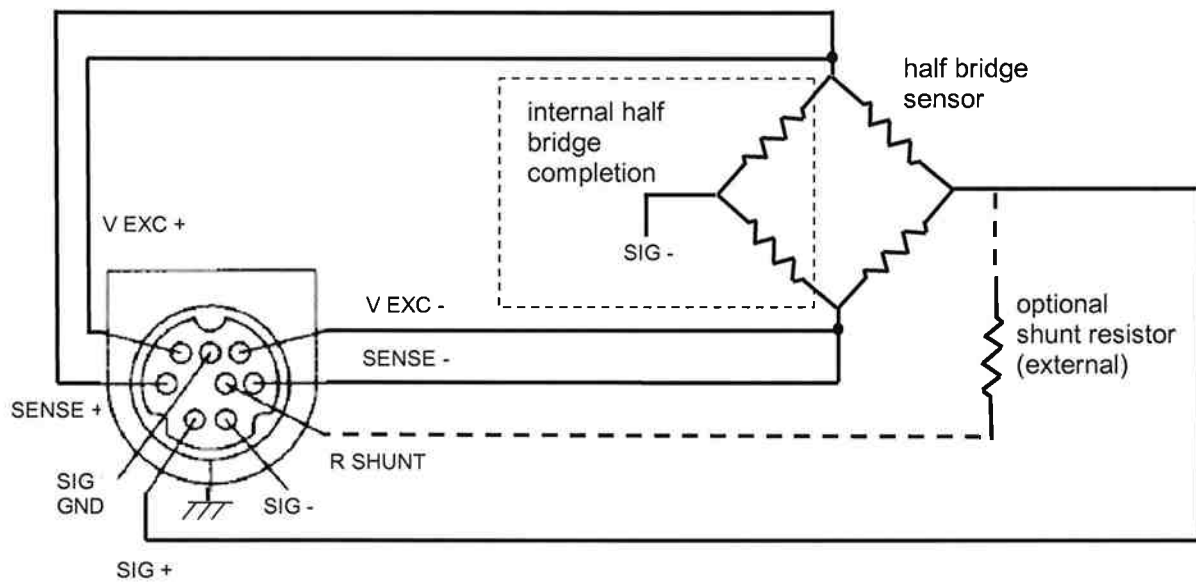
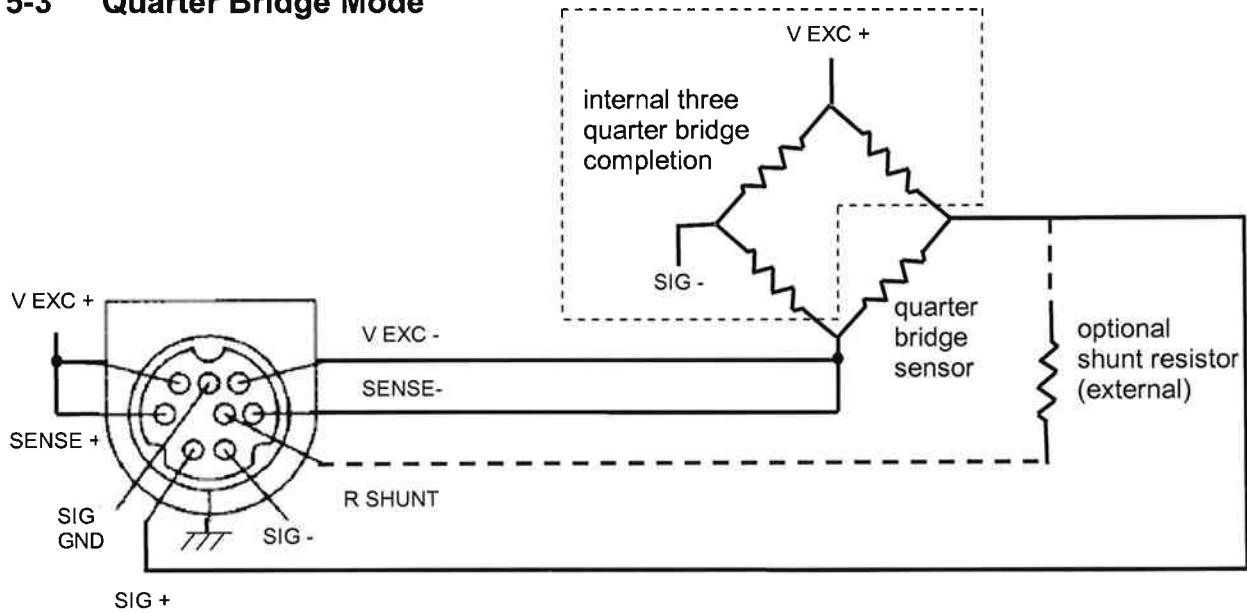

Figure 9 Recommended Connections for Half Bridge Type Sensors
(sense leads wired for optimum performance)

5-3 Quarter Bridge Mode

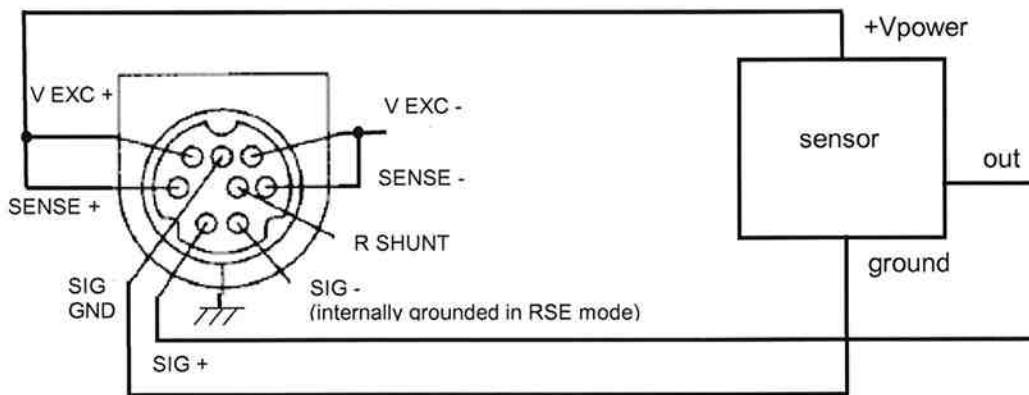

**Figure 10 Recommended Connections for Quarter Bridge Type Sensors
(sense lead wired for optimum performance)**

5-3 RSE / NRSE Mode for 3 Wire Sensors

Three wire sensors having a power connection, a ground connection, and a voltage output may be connected as shown in Figure 11 below. The channel should be set to RSE mode which internally grounds the SIG- input. The voltage output from the sensor (or other source) may then be applied to the SIG+ (non-inverting) input. Set V EXC to unipolar at a voltage appropriate to power the sensor, and ensure that the V EXC lines are tied to the respective SENSE lines.

If an inversion is desired, use NRSE mode which internally connects SIG+ to ground. The voltage output from the sensor may then be applied to the SIG- (inverting) input.



**Figure 11 Recommended Connections for 3 Wire Type Sensor
(channel in RSE mode)**

5-4 Connection of Triaxial Sensors

Many triaxial resistive bridge sensors have shared excitation lines, and other types of sensors may have shared power and ground lines. The V EXC, SENSE, or SIG GND lines for each channel may be tied together, however it is recommended that when doing so the excitation settings for each channel be identical for optimum performance.

Power Return to Case		DC	100Hz	1kHz	10kHz
M1		>1G	2.2E+9	265.0E+6	19.6E+6 Ω
M2		>1G	1.9E+9	263.2E+6	20.2E+6 Ω
100112		>1G	2.2E+9	260.8E+6	18.2E+6 Ω

ISS to Case		DC	100Hz	1kHz	10kHz
M1		>1G	1.8E+9	243.3E+6	12.5E+6 Ω
M2		>1G	1.8E+9	252.8E+6	12.8E+6 Ω
100112		>1G	1.8E+9	237.2E+6	11.1E+6 Ω

Power Return to Case		DC	100Hz	1kHz	10kHz
M1		69.4E-12	69.6E-12	68.6E-12	67.6E-12 pC
M2		68.8E-12	68.4E-12	67.4E-12	66.4E-12 pC
100112		59.4E-12	76.1E-12	75.1E-12	74.0E-12 pC

ISS to Case		DC	100Hz	1kHz	10kHz
M1		62.6E-12	62.3E-12	61.1E-12	60.1E-12 pC
M2		62.4E-12	62.0E-12	61.0E-12	60.0E-12 pC
100112		69.6E-12	69.8E-12	68.7E-12	67.6E-12 pC

Equipment

QuadTech	1659 RLC Digibridge	CD035	11/19/2008	11/19/2010 100Hz, 1kHz, 10kHz
AEMC	1035 Megohmmeter	CA661	8/25/2009	8/25/2010 DC
Electro Scientific Industries	475 Capacitance Meter	EA049	3/17/2009	3/17/2010 DC

	<u>ENGLISH</u>	<u>SI</u>	
Performance			
Channels	8	8	
Sensor Input Type(s)	ICP®, Voltage, Bridge/Differential	ICP®, Voltage, Bridge/Differential	
Accuracy(Gain, x0.1 to x0.4)	± 5 %	± 5 %	
Accuracy(Gain, x0.5 to x0.99)	± 1 %	± 1 %	
Accuracy(Gain, x1.0 to x2000)	± 0.5 %	± 0.5 %	
Accuracy(Excitation)	± 1 %	± 1 %	
Input Range(Differential)	± 0 to 10 V	± 0 to 10 V	
Output Range(Minimum)	± 10 V	± 10 V	
Frequency Range(-5 %)(x100 Gain)	0.05 to 100,000 Hz	0.05 to 100,000 Hz	[5]
Frequency Range(-5 %)(≥100 Gain)	0.05 to 50,000 Hz	0.05 to 50,000 Hz	[5]
Phase Response(at 1 kHz)	± 1 °	± 1 °	
Cross Talk(maximum @ 10kHz)	-72 dB	-72 dB	
Calibration(Shunt)	Internal/External	Internal/External	
TEDS Sensor Support	Yes	Yes	
Fault/Bias Monitor/Meter(LED)	Open/Short/Overload	Open/Short/Overload	
Control Interface			
Digital Control Interface	Ethernet	Ethernet	
Environmental			
Temperature Range(Operating)	+32 to +120 °F	0 to +50 °C	
Electrical			
Power Required(direct input to unit)	AC Power	AC Power	
AC Power(47 to 63 Hz)	100 to 240 VAC	100 to 240 VAC	
AC Power	≤ 0.9 Amps	≤ 0.9 Amps	
Excitation Voltage(To Sensor)	>+24 VDC	>+24 VDC	
Excitation Voltage(Bridge Input)(Positive)	+0 to 12 V	+0 to 12 V	[1]
Excitation Voltage(Bridge Input)(Negative)	-0 to 12 V	-0 to 12 V	[1][2]
Input Imbalance Adjustment(Maximum, Gain <10)	± 2 V	± 2 V	
Input Imbalance Adjustment(Maximum, Gain ≥10)	± 0.2 V	± 0.2 V	
Common Mode Voltage(Maximum)	± 10 V	± 10 V	
DC Offset(Stability, Maximum RTI)	5 μV/°C	5 μV/°C	
DC Offset(AC Coupled)	≤ 50 mV	≤ 50 mV	
DC Offset(DC Coupled, Gain <100)	<10 mV	<10 mV	
DC Offset(DC Coupled, Gain ≥100)	<20 mV	<20 mV	
Current Output(Bridge Input)(Excitation, Maximum)	30 mA	30 mA	
Constant Current Excitation(To Sensor)	0 to 20 mA	0 to 20 mA	
Output Impedance	≤ 50 Ohm	≤ 50 Ohm	
Impedance(Input)	>1 MOhm	>1 MOhm	
Overload Threshold(± 0.2 Vpk)	± 10 Vpk	± 10 Vpk	
Broadband Electrical Noise(1 to 10,000 Hz)(Gain x1)	50 μV rms	50 μV rms	[3]
Spectral Noise(1 Hz)(Gain x1)	6.0 μV/√Hz	6.0 μV/√Hz	[3]
Spectral Noise(10 Hz)(Gain x1)	1.5 μV/√Hz	1.5 μV/√Hz	[3]
Spectral Noise(100 Hz)(Gain x1)	1.0 μV/√Hz	1.0 μV/√Hz	[3]
Spectral Noise(1 kHz)(Gain x1)	1.0 μV/√Hz	1.0 μV/√Hz	[3]
Spectral Noise(10 kHz)(Gain x1)	1.0 μV/√Hz	1.0 μV/√Hz	[3]
Broadband Electrical Noise(1 to 10,000 Hz)(Gain x10)	75 μV rms	75 μV rms	[3]
Spectral Noise(1 Hz)(Gain x10)	20 μV/√Hz	20 μV/√Hz	[3]
Spectral Noise(10 Hz)(Gain x10)	1.5 μV/√Hz	1.5 μV/√Hz	[3]
Spectral Noise(100 Hz)(Gain x10)	1.0 μV/√Hz	1.0 μV/√Hz	[3]
Spectral Noise(1 kHz)(Gain x10)	1.0 μV/√Hz	1.0 μV/√Hz	[3]
Spectral Noise(10 kHz)(Gain x10)	1.0 μV/√Hz	1.0 μV/√Hz	[3]
Broadband Electrical Noise(1 to 10,000 Hz)(Gain x100)	350 μV rms	350 μV rms	[3]
Spectral Noise(1 Hz)(Gain x100)	140.0 μV/√Hz	140.0 μV/√Hz	[3]
Spectral Noise(10 Hz)(Gain x100)	14.0 μV/√Hz	14.0 μV/√Hz	[3]
Spectral Noise(100 Hz)(Gain x100)	8.0 μV/√Hz	8.0 μV/√Hz	[3]
Spectral Noise(1 kHz)(Gain x100)	4.0 μV/√Hz	4.0 μV/√Hz	[3]
Spectral Noise(10 kHz)(Gain x100)	4.0 μV/√Hz	4.0 μV/√Hz	[3]
Broadband Electrical Noise(1 to 10,000 Hz)(Gain x1000)	3000 μV/rms	3000 μV/rms	[4]
Physical			
Electrical Connector(ICP® Sensor Input)	BNC Jack	BNC Jack	
Electrical Connector(Bridge/Differential)	8-socket mini DIN	8-socket mini DIN	
Electrical Connector(Output)	BNC Jack	BNC Jack	
Electrical Connector(Ethernet)	RJ-45	RJ-45	
Size (Height x Width x Depth)(nominal)	1.75 in x 19.0 in x 13.7 in	44.5 mm x 482.6 mm x 348 mm	
Weight	7.0 lb	3.18 Kg	

OPTIONAL VERSIONS

Optional versions have identical specifications and accessories as listed for the standard model except where noted below. More than one option may be used.

- NOTES:**
- [1] Adjustable in 0.1V steps.
 - [2] Negative excitation can be set to 0V or to track the positive excitation voltage.
 - [3] Typical, AC Coupled.
 - [4] Bridge/Differential Mode, DC Coupled with 350 ohm bridge
 - [5] AC coupled mode (low frequency response is 0Hz in DC Coupled mode.)
 - [6] See PCB Declaration of Conformance PS023 for details.

SUPPLIED ACCESSORIES:

Model 017AXX Power Cord (1)
Model EE75 PCB MCSC Control Software. (1)

Entered: AP	Engineer: AJP	Sales: JJM	Approved: JWH	Spec Number:
Date: 3/21/2013	Date: 3/21/2013	Date: 3/21/2013	Date: 3/21/2013	43990



*All specifications are at room temperature unless otherwise specified.
In the interest of constant product improvement, we reserve the right to change specifications without notice.*

ICP® is a registered trademark of PCB Group, Inc.

Phone: 716-684-0001
Fax: 716-684-0987
E-Mail: info@pcb.com

3425 Walden Avenue, Depew, NY 14043

PCB Piezotronics Inc. claims proprietary rights in the information disclosed hereon. Neither it nor any reproduction thereof will be disclosed to others without the written consent of PCB Piezotronics Inc.

43989

REVISIONS		
REV	DESCRIPTION	DIN
B	UPDATED DIMENSIONS TO 1.75,18.3,1.25	40833

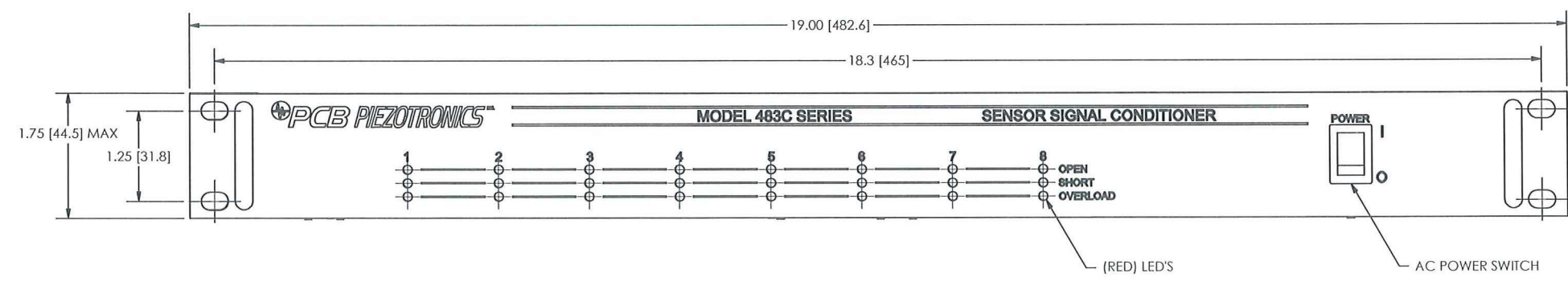
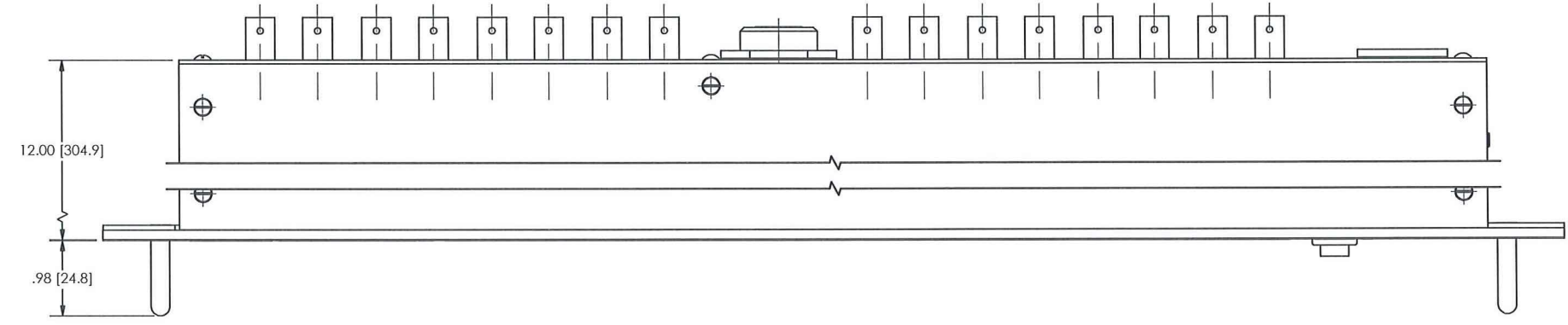
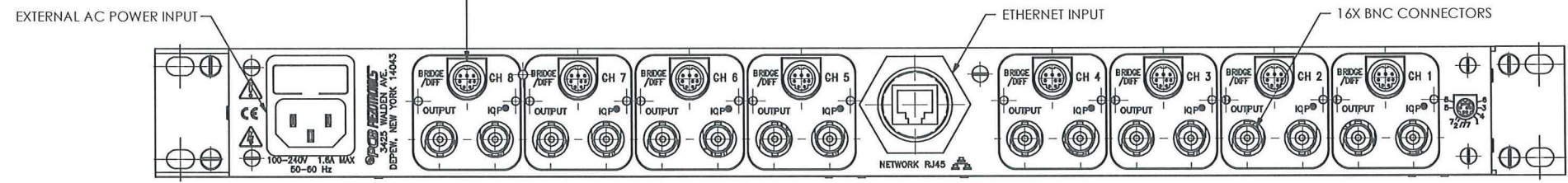

UNLESS OTHERWISE SPECIFIED TOLERANCES ARE:		DRAWN	CHECKED	ENGINEER
DIMENSIONS IN INCHES	DIMENSIONS IN MILLIMETERS [IN BRACKETS]	JDM	3/27/13	AJP
DECIMALS XX ±.03 XXX ±.010	DECIMALS X ±0.8 XX ±0.25	TITLE		
ANGLES ± 2 DEGREES	ANGLES ± 2 DEGREES	OUTLINE DRAWING MODEL 483C28 SENSOR SIGNAL CONDITIONER		
FILLETS AND RADII .003 - .005	FILLETS AND RADII 0.07 - 0.13	PCB PIEZOTRONICS™ 3425 WALDEN AVE. DEPEW, NY 14043 (716) 684-0001 E-MAIL: sales@pcb.com		
		CODE IDENT. NO. 52481	DWG. NO. 43989	SCALE: .75X SHEET 1 OF 1